

TTB3045NX Exploded Spares

Walk-behind Battery Scrubber Dryer

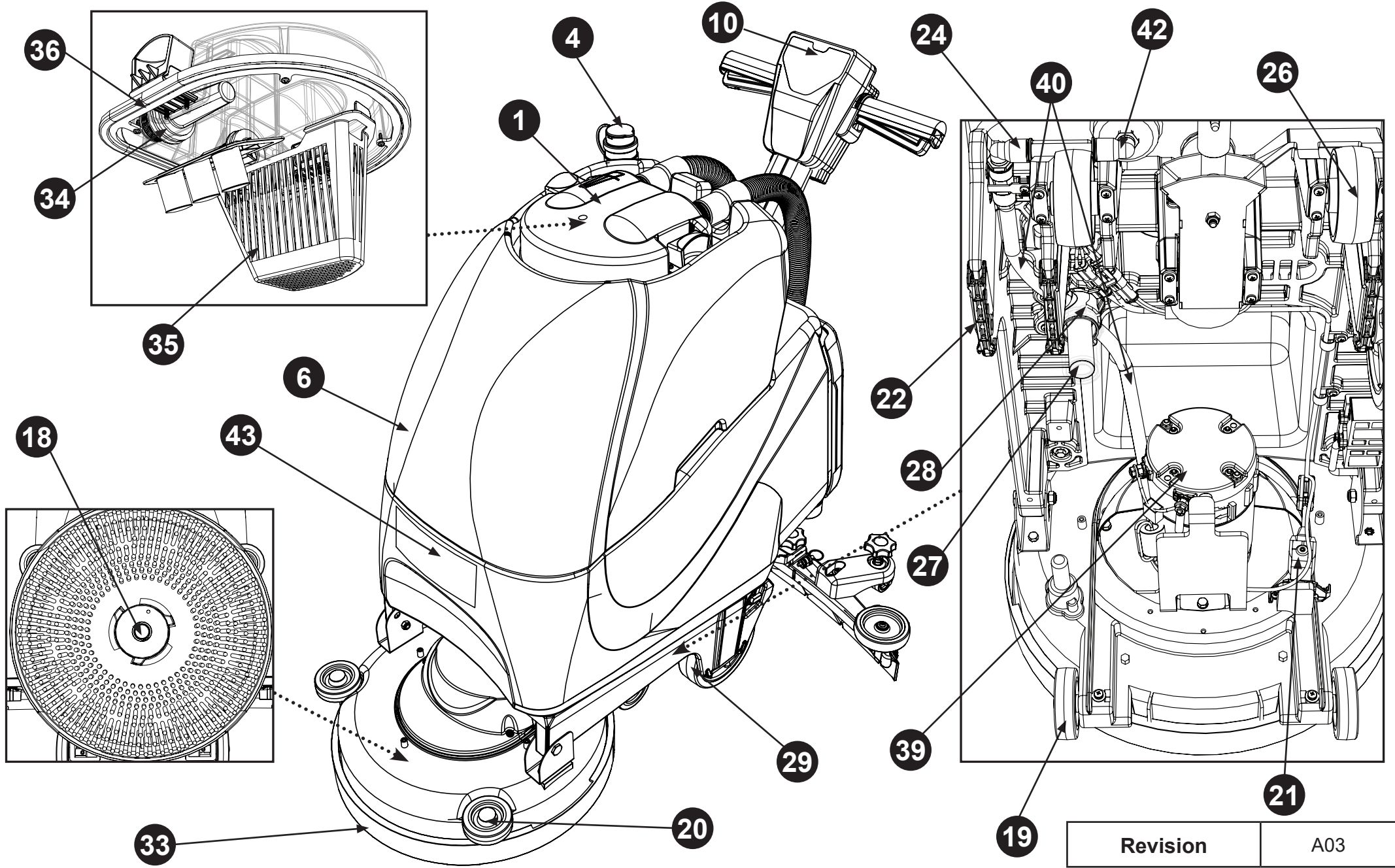

Revision	A03
----------	-----

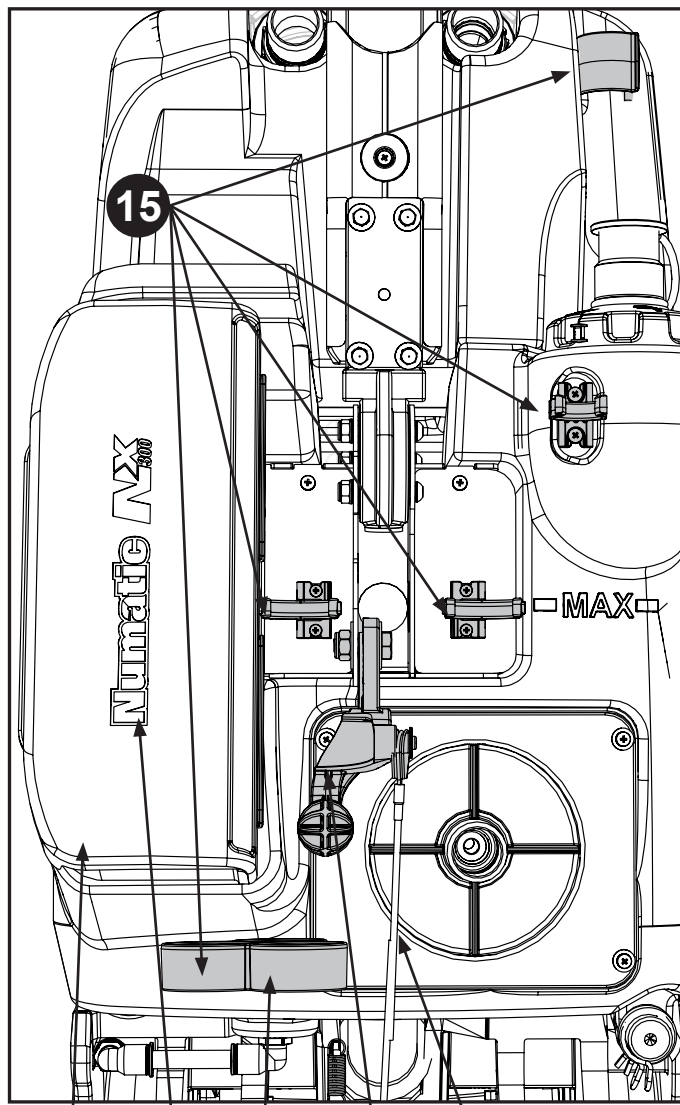

- 32
- 44
- 16
- 38
- 37
- 9

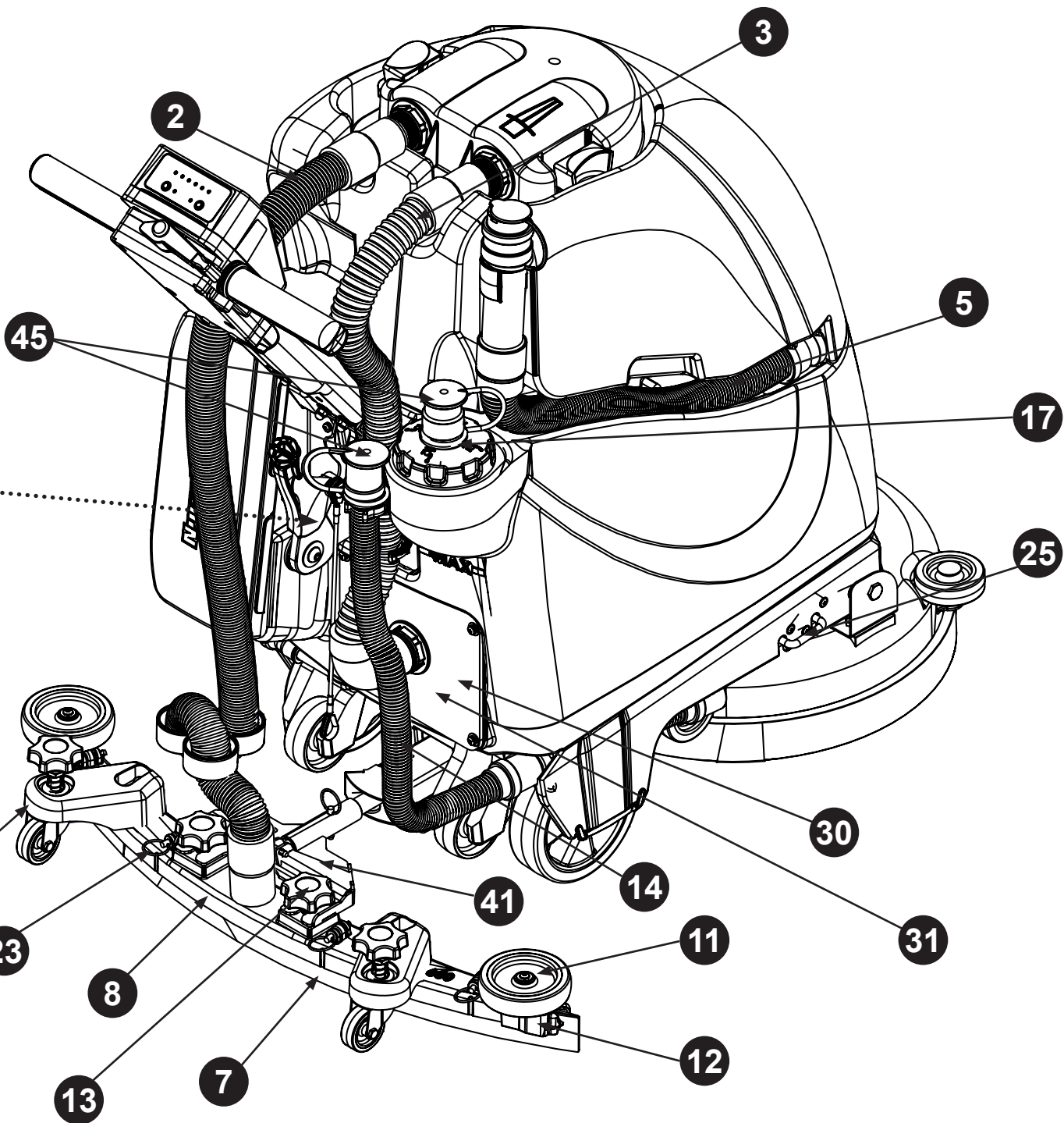

- 2
- 3
- 5
- 17
- 25
- 30
- 31
- 14
- 11
- 12
- 7
- 8
- 13
- 23
- 41
- 45

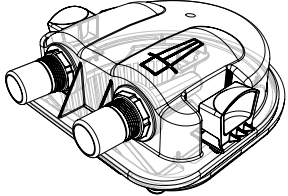
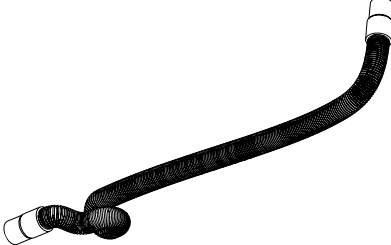
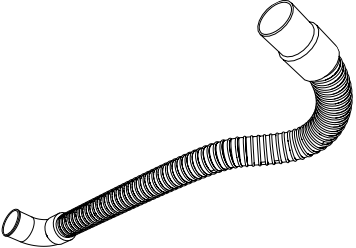
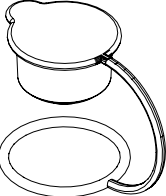
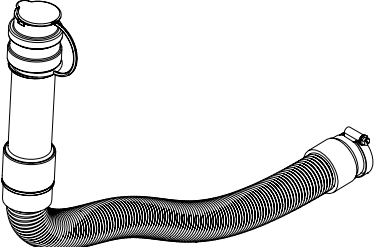
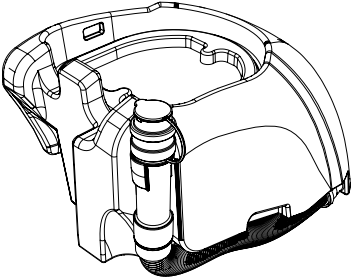
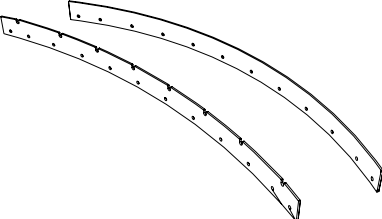
Item Number	Image Reference	Item Description	Part Number	Item Quantity
1		Separator Assembly	915088	1
2		Stretch Hose	915089	1
3		Vac Hose	915090	1
4		Dirty Dump Hose End Cap	915091	1
5		Dirty Dump Hose	915092	1
6		Top Tank Assembly	915094	1
7		Blade Set	900518	1

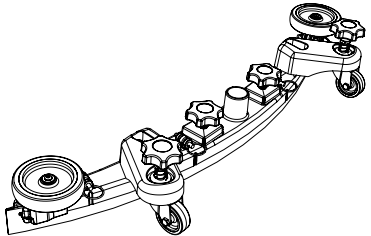
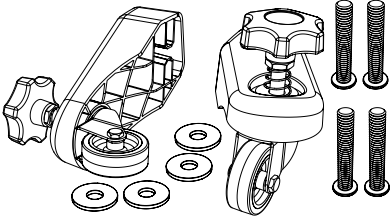
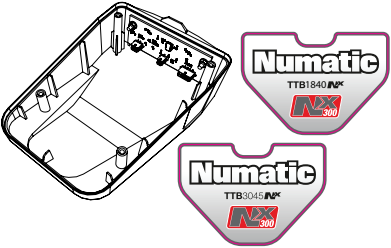
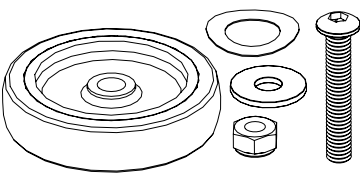
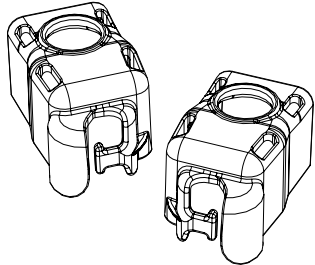
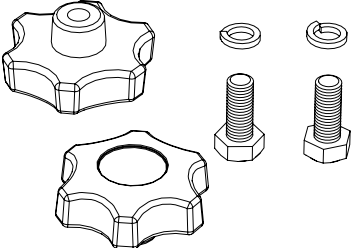
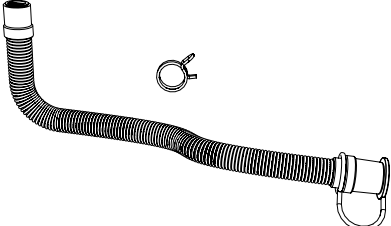
Item Number	Image Reference	Item Description	Part Number	Item Quantity
8		Complete Floortool Kit	904691	1
9		Right & Left Caster Wheel Assy	908028	1
10		PCB Kit	915095	1
11		Squeegee Buffer Wheel	916150	2
12		Floor Tool Right & Left Blade Retainer Clips	916152	1
13		Floor Tool Red Knob	916153	2
14		Clean Water Dump Hose	916154	1

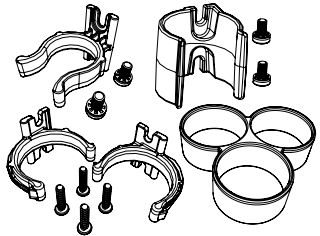
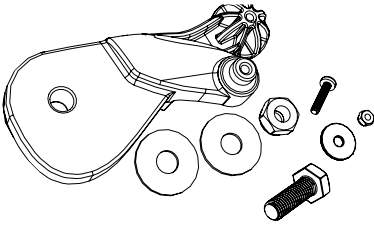
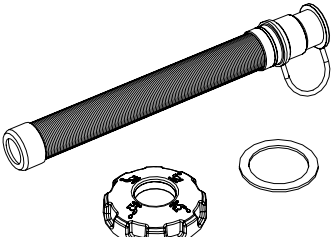
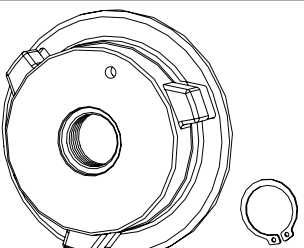
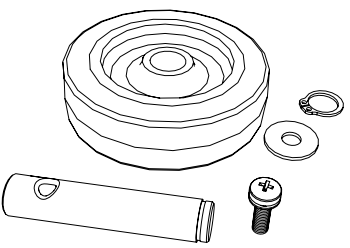
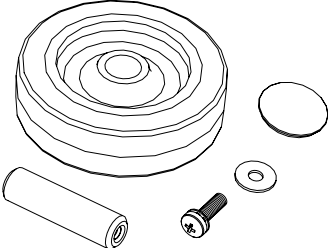
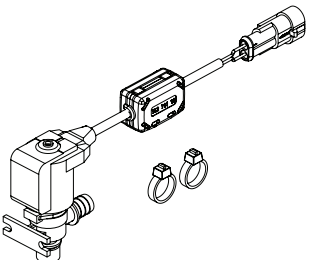
Item Number	Image Reference	Item Description	Part Number	Item Quantity
15		Complete Hose Clip Kit	916155	1
16		Squeegee Lift Handle Kit	916156	1
17		Tank Filling Kit	916157	1
18		Chuck Kit	916158	2
19		Wheel Kit	916159	1
20		Buffer Wheel Kit	916160	2
21		Solenoid Cable & Ferrite Assembly	916197	1

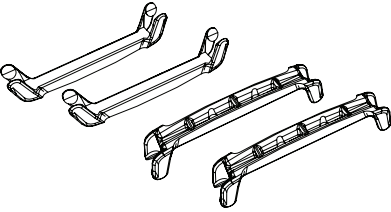
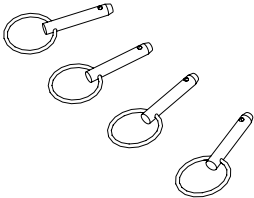
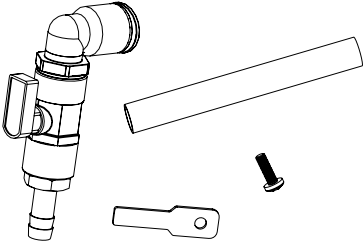
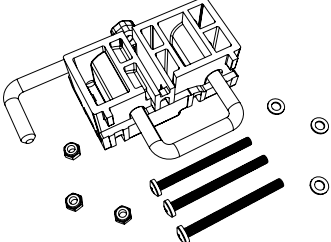
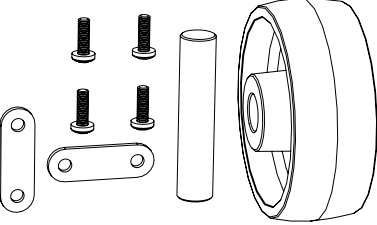
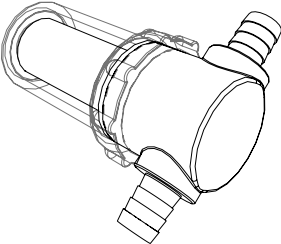
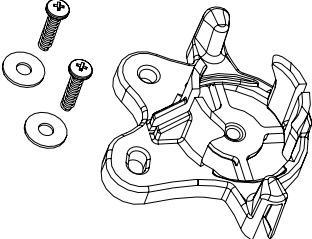
Item Number	Image Reference	Item Description	Part Number	Item Quantity
22		Pack of Axle Clips	916183	4
23		Pack of Detent Pins	916184	4
24		Ball Valve Assy	916186	1
25		Deck Bar Locking Kit	905533	1
26		80mm White Wheel Kit	916188	1
27		Extended Strainer Kit	916190	1
28		Extended Strainer Bracket Assy	916192	1

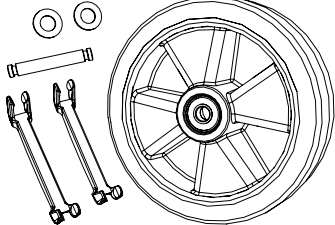
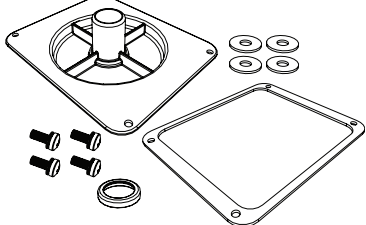
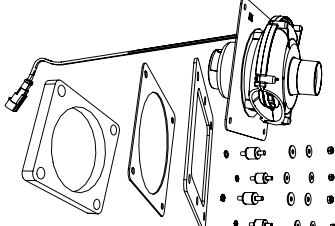
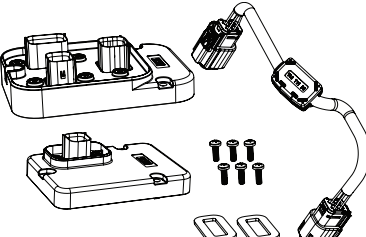
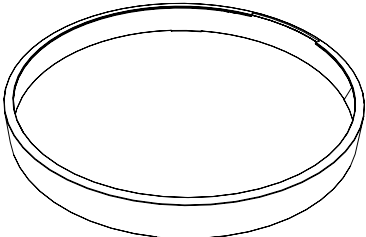
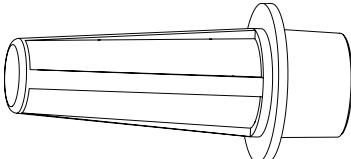
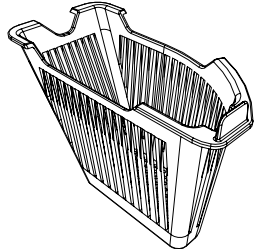
Item Number	Image Reference	Item Description	Part Number	Item Quantity
29		160mm Wheel Kit Assy	916194	1
30		Vac Motor Back Plate Assy	916406	1
31		Vac Motor Assy	916408	1
32		Main PCB Kit Assy	916411	1
33		Splash Skirt	916413	1
34		Barrel Filter	916414	2
35		Filter Basket	916415	1

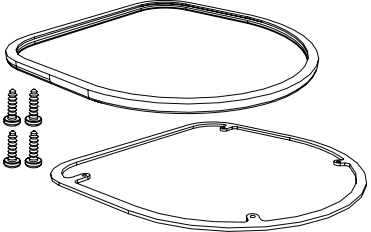
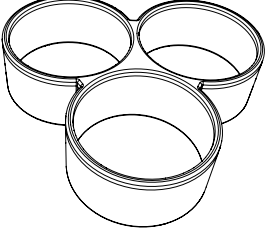
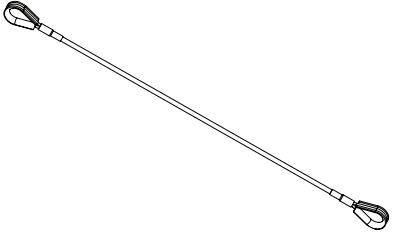
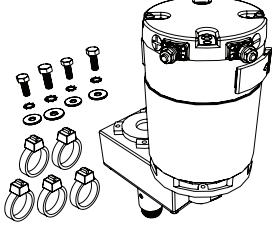
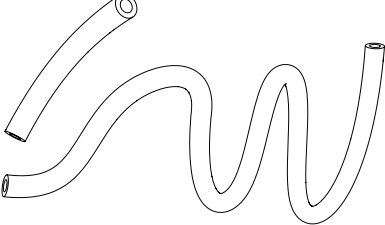
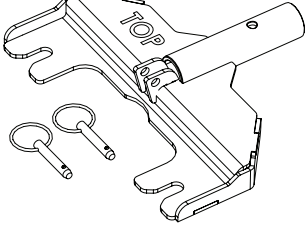
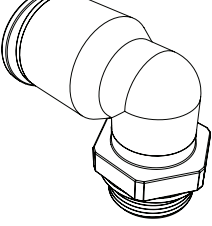
Item Number	Image Reference	Item Description	Part Number	Item Quantity
36	 <p>The image shows two identical, roughly rectangular gaskets with rounded corners and a small notch on one side. To the left of the top gasket, there are three small circular components, likely O-rings or seals, stacked vertically.</p>	Seperator Gasket Kit	916417	1
37	 <p>The image shows three circular components that serve as hose guides. Two are positioned at the top, slightly overlapping each other, and one is centered below them.</p>	Hose Guide (Top Tank)	916418	1
38	 <p>The image shows a long, thin metal wire with a hook at each end, used for lifting components.</p>	Lift Wire	916288	1
39	 <p>The image shows a brush motor assembly consisting of a cylindrical motor housing with a mounting base and several small electrical components and connectors scattered to the left.</p>	Brush Motor Assy	916290	2
40	 <p>The image shows a kit of solution tubes, including a long, thin tube and a shorter, thicker tube, both with one end slightly flared.</p>	Solution Tube Kit	916292	1
41	 <p>The image shows a metal floor tool bracket assembly with a main bracket and two small pins or screws.</p>	Floor Tool Bracket Assy	916293	2
42	 <p>The image shows an elbow angle connector, which is a cylindrical fitting with a 90-degree bend and a threaded end.</p>	Elbow Angle Connector	916295	1

TTB3045NX Exploded Spares

Walk-behind Battery Scrubber Dryer

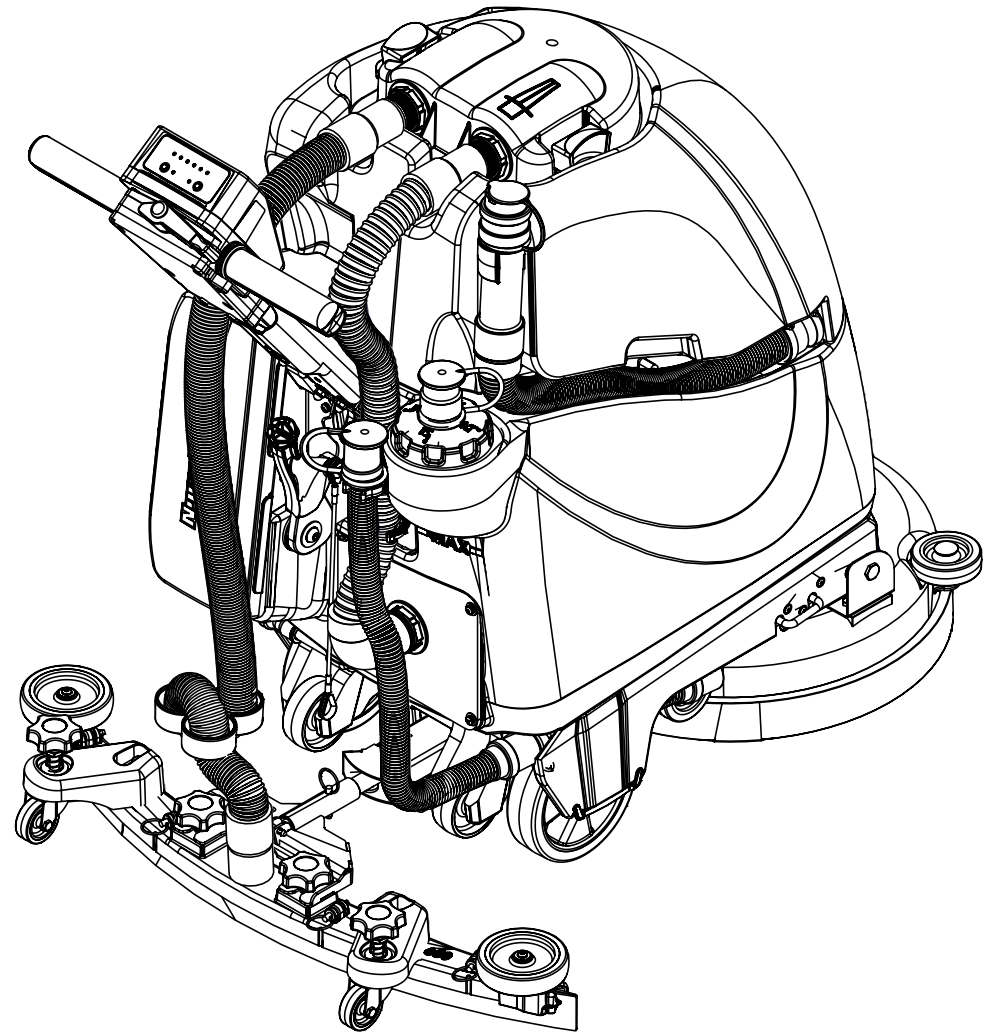
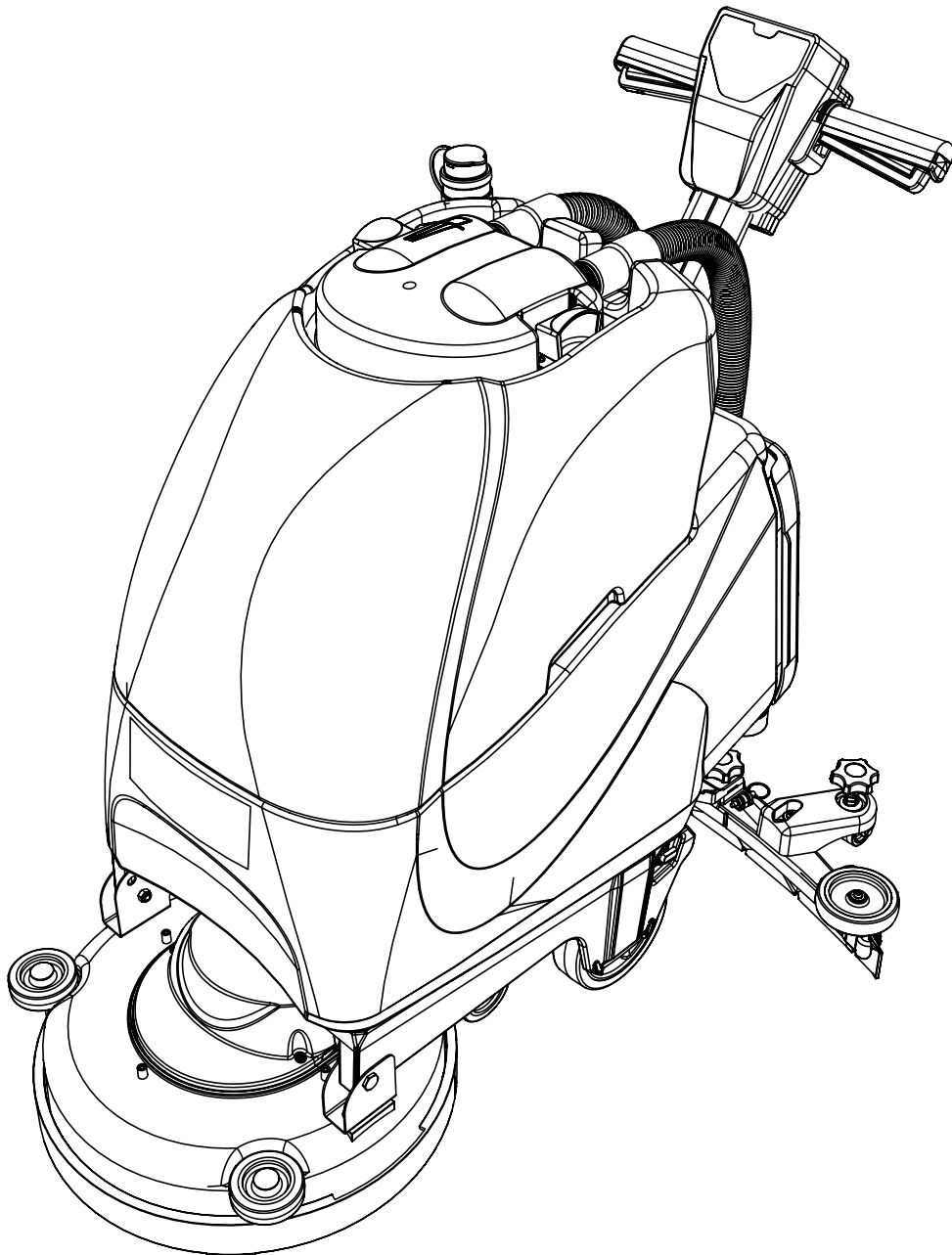

UK	 	Any maintenance operation is to be carried out in a safe environment • All electrical work is to be carried out by a competent person Move tank assembly • Retain all nuts, screws and washers for refitting (If applicable)	 
DL	 	Sämtliche Wartungsarbeiten sind in einer sicheren Umgebung durchzuführen • Alle Elektroarbeiten sind durch eine entsprechend befähigte Person durchzuführen Bewegen Sie die Tankbaugruppe • Bewahren Sie alle Muttern, Schrauben und Unterlegscheiben zum Wiedereinbau sicher auf (falls zutreffend)	 
ES	 	Toda operación de mantenimiento debe realizarse en un entorno seguro • Todo trabajo eléctrico debe ser realizado por una persona competente Mover el conjunto de depósito • Guardar todas las tuercas, tornillos y arandelas para volver a colocarlos (si corresponde)	 
FL	 	Kaikki huoltotoimenpiteet on suoritettava turvallisessa ympäristössä • Ammattitaitoisien henkilöiden on tehtävä kaikki sähkötyöt Siirrä säiliöyksikkö • Säilytä kaikki mutterit, ruuvit ja prikat asennusta varten (jos käyttökelpoisia)	 
FR	 	Toute opération d'entretien doit être effectuée dans un environnement sécurisé • Tous travaux électriques doivent être assurés par du personnel qualifié uniquement Déplacez l'ensemble réservoir • Conservez tous les écrous, vis et rondelles en vue d'un (éventuel) remplacement	 
IT	 	Tutti gli interventi di manutenzione devono essere effettuati in un ambiente sicuro • Tutti gli interventi elettrici devono essere effettuati da personale competente Spostamento del gruppo serbatoio • Conservare tutti i dadi, le viti e le rondelle per il rimontaggio (se applicabile)	 
NL	 	Alle onderhoudswerkzaamheden moeten worden uitgevoerd in een veilige omgeving • Alle elektrische werkzaamheden moeten worden uitgevoerd door een bevoegd persoon Verplaats de hoofdtank • Bewaar alle moeren, schroeven en sluitringen voor hermontage (indien van toepassing)	 
PL	 	Wszystkie czynności konserwacyjne należy wykonywać w bezpiecznym środowisku • Wszelkie prace elektryczne powinna wykonywać osoba kompetentna Przesunąć zespół zbiornika • Zachować wszystkie nakrętki, śruby i podkładki do ponownego montażu (jeżeli dotyczy)	 
PT	 	Qualquer operação de manutenção deve realizar-se num ambiente seguro • Todo o trabalho elétrico deve ser realizado por um técnico qualificado Mover o depósito principal • Guardar todas as porcas, parafusos e anilhas para reinstalar (se aplicável)	 
SV	 	Alla former av underhåll ska utföras i en säker miljö • Allt elektriskt arbete ska utföras av en behörig person Flytta tankenheten • Behåll alla muttrar, skruvar och brickor för reparation (om det är tillämpligt)	 
DK	 	Any maintenance operation is to be carried out in a safe environment • All electrical work is to be carried out by a competent person • Move tank assembly Retain all nuts, screws and washers for refitting (If applicable)	 



For videos and help
scan the QR code.

Num Assist



Numatic.com



Numatic

